

eCoal.pl

V3.5

Adaptive controller

Software version: 1.1.20.0

Operating manual

Kutno

2016-10-07

Table of Contents

1. Safety.....	3
2. Assembly.....	5
2.1 Environmental conditions.....	5
2.2 Control panel setup.....	5
2.3 Connecting the sensors.....	6
2.4 Sensor of breaking a split pin.....	8
2.5 Sensor of closing the storage unit.....	8
2.6 Connecting the 230V AC automation devices.....	8
3. Operation of the controller.....	9
3.1 Operator panel.....	9
3.2 Operator panel - operation level.....	10
3.2.1 Home screens.....	10
3.2.2 Main screen.....	11
3.2.3 DHW screen.....	12
3.2.4 Feeder screen.....	13
3.2.5 CH.1 and CH.2 circuits screen.....	14
3.2.6 Network screen.....	15
3.2.7 Alarm screen.....	16
3.2.8 Manual control screen.....	17
3.2.9 Operating mode screen.....	18
4. Controller parameters.....	19
4.1 Combustion parameters.....	19
4.1.1 Combustion parameters – Retort - eCoal type.....	20
4.1.2 Combustion parameters – Retort - group type.....	20
4.1.3 Combustion parameters – Retort - manual type.....	21
4.1.4 Combustion parameters – top-loading type.....	22
4.1.5 Uphold parameters.....	23
4.1.6 Blower power in manual mode.....	24
4.2 Boiler settings.....	24
4.3 CH.1 circuit.....	25
4.4 CH.2 circuit screen.....	28
4.5 DHW circuit.....	29
4.6 Programmers.....	30
4.7 Internet.....	32
4.8 Date and time.....	33
4.9 Advanced parameters.....	34
5. Alarms.....	36

Technical data

Power supply.....	230V~50Hz
Protection degree.....	IP40
Electrical protection class.....	I
Acceptable ambient temperature range.....	from 5°to 45°C without condensation
Feeder line load.....	to 1 A
Blower line load.....	to 0.8 A
Each line pump load.....	to 0.5 A
Valve line load.....	to 0.2 A
Fuses	4 A

1. Safety

- Prior to starting the assembly works read the following instructions and the warranty. Incorrect assembly, operation and handling not in line with this manual will void any applicable warranties.
- Assembly and installation works should be carried out by an authorized service or suitably qualified specialists, in accordance with the applicable regulations and standards.
- This controller can be used by children of 8 years old or above, people with physical or mental disabilities and people with no experience or knowledge of using this device if supervision and training of safe use is provided in order to understand all possible hazards and risks related to this appliance. Children should not be allowed to play with this appliance. Unattended children should not clean or maintain this device.
- If the non-detachable power cord is damaged, it should be replaced by a manufacturer, a repair service employee or a trained person in order to avoid any risks.
- The controller should be connected to installations with socket with earth

pin, because of safety reasons and electromagnetic interferences which can influence the operation of controller and devices working with it.

- Do not expose the controller to excessive humidity causing condensation (e.g. in rapid external temperature changes) and avoid spilling water on it.
- Do not expose the controller to temperatures higher than 45°C and lower than 5°C.
- In case of burning wood in the boiler remove the sensor from the flue.
- Electrical wiring must be well secured and cannot touch the water jacket of the boiler or the exhaust outlet.
- Always unplug the controller from the mains before connecting/disconnecting controller-powered devices.
- During storm the controller should be disconnected from the 230V mains and the Ethernet.
- The installation to which the controller is to be connected should be equipped with fuses suitable for the electrical loads and in accordance with the applicable regulations and standards.
- Do not install a controller with mechanically damaged casing, damaged or broken wiring.
- Only authorized service can repair the controller. Otherwise warranty will become void.
- Exhaust temperature sensor should be cleaned at least once a month.
- The end of exhaust temperature sensor should be positioned in the middle of the flue's diameter.
- In case of using sensor wiring longer than 5m it is advised to use shielded pair cable. Cable shield should be connected to PE terminal only from the side of the controller.

2. Assembly

Assembly and installation works should be carried out by an authorized service or suitably qualified specialists, in accordance with the applicable regulations and standards.

2.1 Environmental conditions

Do not expose the controller to excessive humidity causing condensation (e.g. in rapid external temperature changes) and avoid spilling water on it.

Do not expose the controller to temperatures higher than 45°C and lower than 5°C.

2.2 Control panel setup

Connection made in accordance with the pictures below

[yellow – green – white – brown]

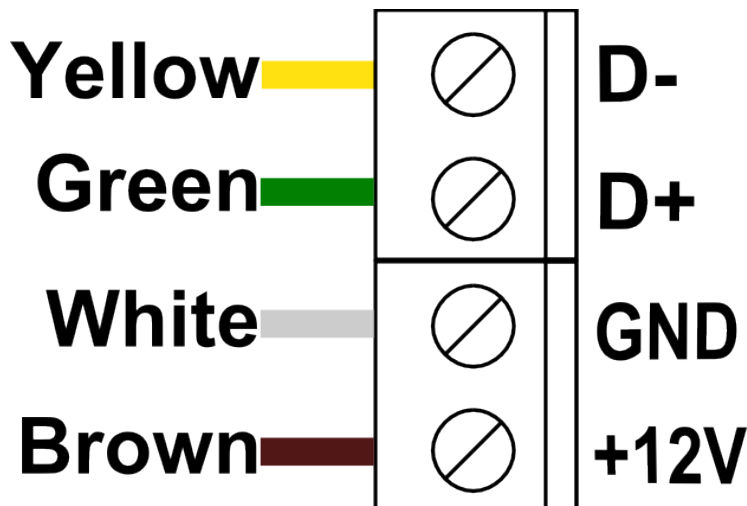

Picture 1: Connecting the Standard panel

Recommended cable: LIYY 4x0.25mm².

2.3 Connecting the sensors

Activation of the devices connected and the controller functions is automatic and depends only on connecting the temperature sensors to the controller. For example: connecting a domestic hot water (DHW) temperature sensor activates the pump, and connecting a sensor of external temperature makes it automatically possible to use weather compensator, and so on. The sensors should be inserted into the controller through a suitable cable grommet (description on the casing) and connected as described in the manual. All sensors are of KTY-81-210 type, and the exhaust temperature sensor is of KTY-81-210 type.

If there is no sensor connected, it is signaled with lines marked next to the sensor's description.



The controller has a function of faulty sensors detection. Always unplug the controller from the 230V AC mains before connecting/disconnecting sensors.

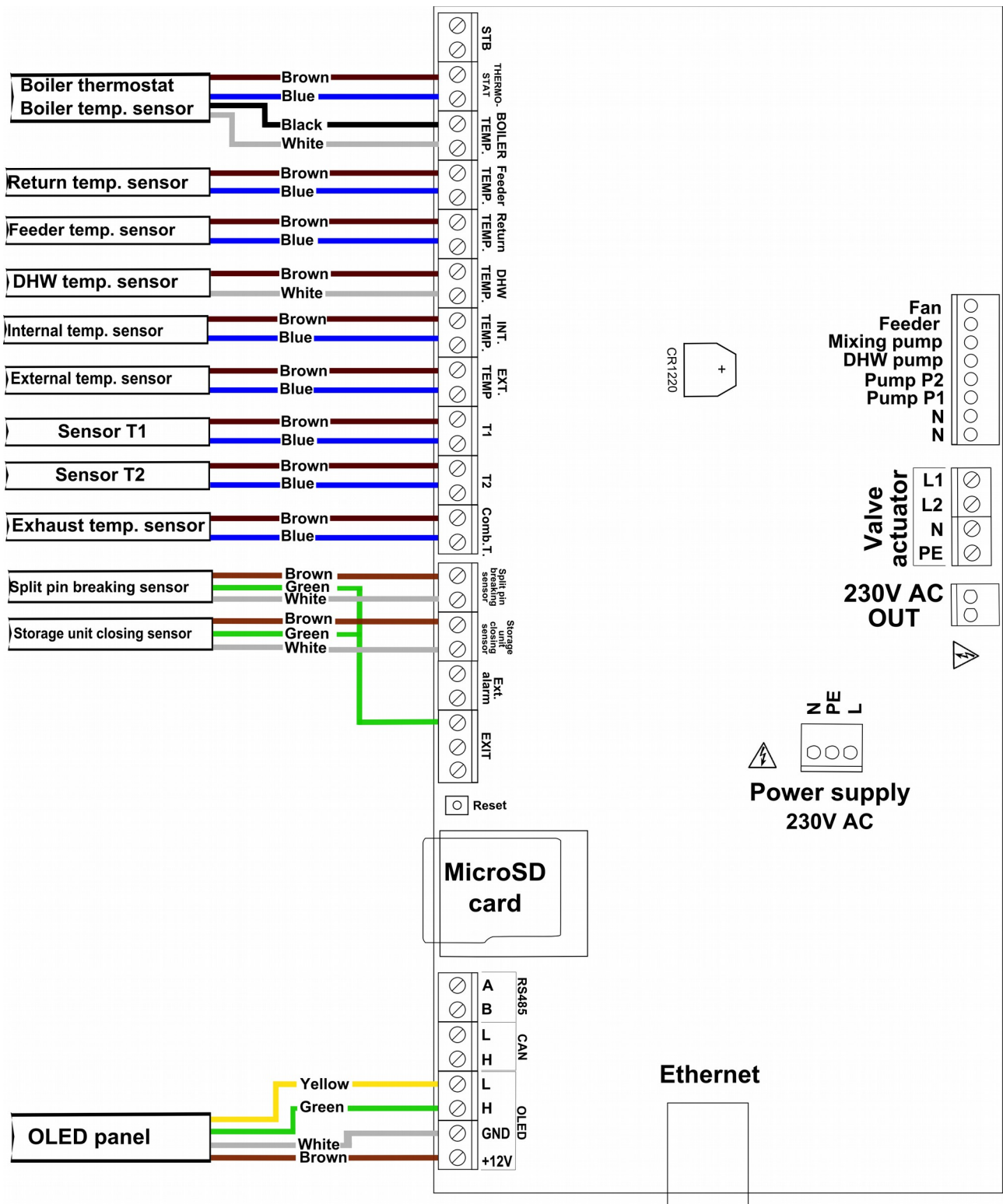

Picture 2: Terminal strip for connecting the sensors

2.4 Sensor of breaking a split pin

Split pin breaking sensor should be connected as shown on the picture 4. The sensor helps to diagnose problems with the operation of the feeder.

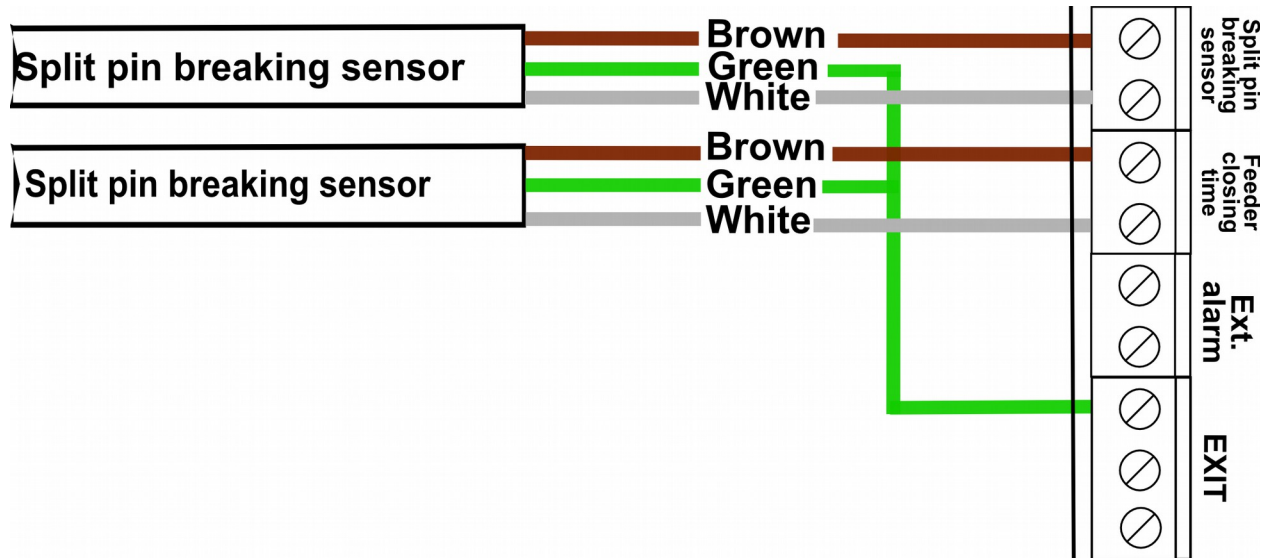

Picture 3: Connecting the sensors of split pin breaking and of closing the storage unit.

2.5 Sensor of closing the storage unit

Here we can connect **Storage unit closing sensor** – which signals the proper closing of the storage unit cover. At the moment of opening the cover, the controller will be switched to alarm mode with alarm message "**Open storage unit**". Connect the sensor as shown on the picture 3.

2.6 Connecting the 230V AC automation devices

Following equipment can be connected to the controller:

- Fan (white socket)
- Feeder (grey socket)
- Pump P1
- Pump P2
- DHW pump





- Mixing , circulation or boiler feed pump

Follow the instructions given on the casing.

3. Operation of the controller

3.1 Operator panel

The LCD operator panel is equipped with a OLED graphic display, six buttons and pictograms with LEDS signaling the operation of the following equipment:

- fan 
- feeder 
- DHW pump 
- pumps P1 and P2 
- alarm 





	<ul style="list-style-type: none"> • navigating menu
	<ul style="list-style-type: none"> • changing parameter values
	<ul style="list-style-type: none"> • choice confirmation • entering the controller settings from the main screen (pressing the button for 2s)
	<ul style="list-style-type: none"> • canceling • returning to the main menu • keeping the button pressed (2s) allows to quickly switch the controller's operating modes: Manual, AUTO

Table 1: Button functions

After 30 minutes of inactivity the display will run a screensaver - the current time will be displayed on the screen. To go back to the information about the boiler please press any button on the operator panel.

3.2 Operator panel - operation level

In case of incorrect communication between the panel and the controller a message: **"No communication, check the controller connection"** will be displayed.

3.2.1 Home screens

The following information is displayed on the home screen right after activating the controller:

First screen:

- Type and model of the display
- Version of the display software



OLED-GLASS
PANEL_EC
1.0.0.31

Picture 4: Type and model of the display and software version

Second screen:

- Controller type
- Controller version

eCoal
1.1.0.22

Picture 5: Controller type and software version

3.2.2 Main screen

The following information is available on the main screen:

- measured and set temperatures of the boiler
- exhaust temperature
- return temperature when the sensor is connected
- external temperature when the sensor is connected
- controller operating mode: Manual, Auto, Alarm





	<ul style="list-style-type: none">• active weather programmer
	<ul style="list-style-type: none">• reduced temperature on the boiler
	<ul style="list-style-type: none">• mixing pump operation
	<ul style="list-style-type: none">• external temperature

Table 2: Symbols on the main screen

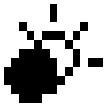

Picture 6: Main screen



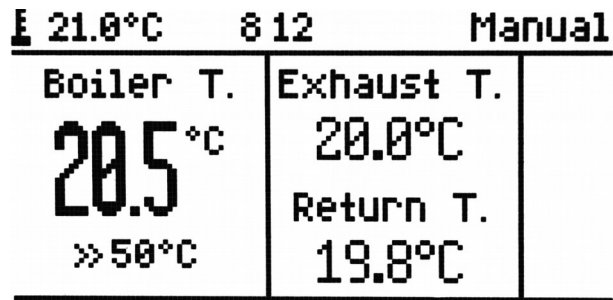





	<ul style="list-style-type: none"> • navigate the information screens
	<ul style="list-style-type: none"> • go to setting the boiler temperature
	<ul style="list-style-type: none"> • go to setting the boiler reduced temperature
	<ul style="list-style-type: none"> • go to the controller settings – pressing for 2s
	

Table 3: Functions of the buttons on the main screen

3.2.3 DHW screen

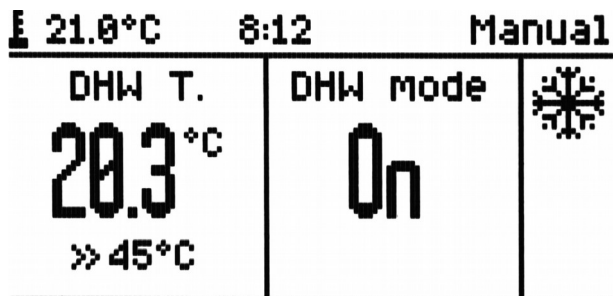

Picture 7: DHW operation screen

	<ul style="list-style-type: none"> • circulation pump operation
	<ul style="list-style-type: none"> • summer mode
	<ul style="list-style-type: none"> • winter mode

P	<ul style="list-style-type: none"> DHW priority
----------	--

Table 4: Symbols on the DHW screen





	<ul style="list-style-type: none"> navigate the information screens
	<ul style="list-style-type: none"> go to setting the DHW temperature
	<ul style="list-style-type: none"> go to setting the DHW mode
	<ul style="list-style-type: none"> go to the controller settings – pressing for 2s
	<ul style="list-style-type: none"> return to the main menu

Table 5: Functions of the buttons on the DHW screen

DHW operating modes:

- Zal** – DHW active (ON)
- Wyl** – DHW inactive (OFF)
- Prog** – DHW active in line with the settings of its programmer
- +1h** – DHW active for one hour After this time the DHW returns to its previous mode.
- +2h** – DHW active for two hours After this time the DHW returns to its previous mode.

3.2.4 Feeder screen

❄ 0min	8 12	Manual
Feeder T.	Fuel	
19.8 °C	0%	
	Fan power	
	0%	

Picture 8: Feeder screen



	<ul style="list-style-type: none"> • navigate the information screens
	<ul style="list-style-type: none"> • go to adding new coal batch
	<ul style="list-style-type: none"> • return to the main menu

Table 6: Functions of the buttons on the feeder screen

The controller makes it possible to generate entries to the events archive about new fuel batch fed to the storage unit and a notification of low level of fuel in the storage unit. Feeder working time is used to deduct it.

3.2.5 CH.1 and CH.2 circuits screen

Screens are available depending on the type of CH (central heating) circuit chosen.

The following information is available on the CH screen:

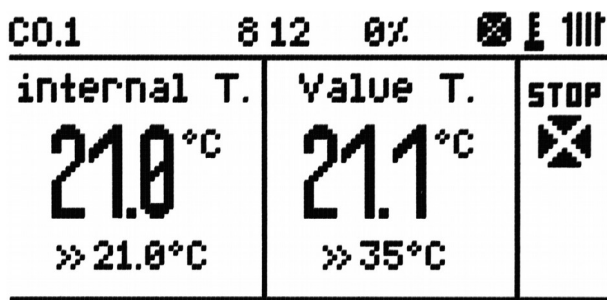

- measured and set external temperature
- temperature measured and set behind the valve - only for the CH circuit
- valve opening angle - only for the CH circuit

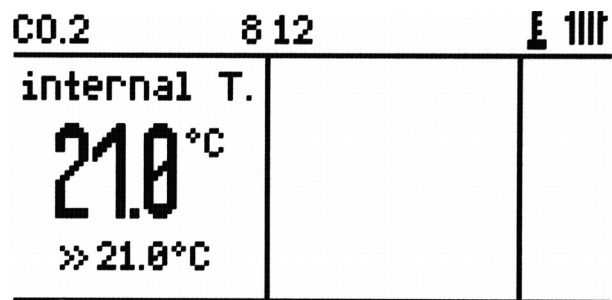

Picture 9: CH.1 circuit screen



Picture 10: CH.2 circuit screen

	<ul style="list-style-type: none"> • navigate the information screens
	<ul style="list-style-type: none"> • go to setting the temperature behind the valve
	<ul style="list-style-type: none"> • go to setting the reduced temperature behind the valve



	<ul style="list-style-type: none"> • go to the controller settings – pressing for 2s
	<ul style="list-style-type: none"> • return to the main menu

Table 7: Functions of the buttons on the CH.1 screen





	<ul style="list-style-type: none"> • CH pump operation
	<ul style="list-style-type: none"> • active room thermostat
	<ul style="list-style-type: none"> • circuit type - central heating (CH) or floor heating
	<ul style="list-style-type: none"> • valve operating mode (only for the CH.1 circuit)

Table 8: Symbols on the CH.1 and CH.2 circuits screen

3.2.6 Network screen

The following information is available on the network screen:

- state of network cable connection
- IP address, mask and gateway
- state of connection to the eSterownik.pl platform:
 - online – connection is correct
 - offline – not connected to the platform

```

Network 8 24      Online
-----
IP 192.168.3.165
Mask 255.255.252.0
Gateway 192.168.0.254
-----

```

Picture 11: Network settings screen

3.2.7 Alarm screen

The screen lists current alarms.

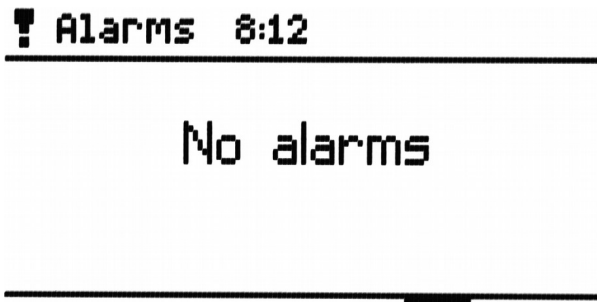

Picture 12: Alarm screen





	<ul style="list-style-type: none">• navigate the information screens
	<ul style="list-style-type: none">• alarm review
	<ul style="list-style-type: none">• confirmation of all alarms
	<ul style="list-style-type: none">• return to the main menu
	<ul style="list-style-type: none">• each button mutes audible alarms

Table 9: Functions of the buttons on the alarm screen

An additional device for signaling a controller alert (e.g. an alarm light, a buzzer) can be connected to the controller.

Input parameters:

- Maximum voltage: 24V DC,
- Maximum load current: 50mA

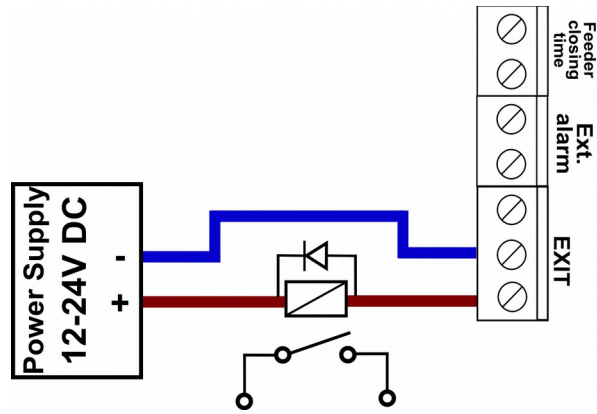

Picture 13: Connection of an additional alarm receiver to the alarm output

3.2.8 Manual control screen

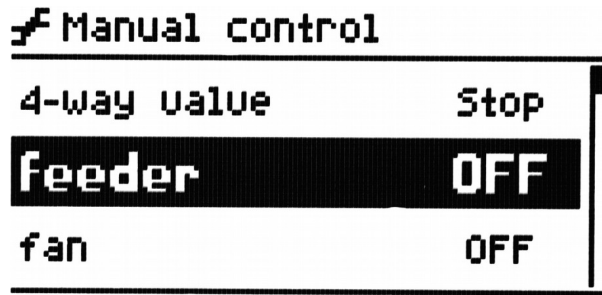

Picture 14: Manual control screen







 	<ul style="list-style-type: none"> • navigate the information screens
 	<ul style="list-style-type: none"> • selection of a device
	<ul style="list-style-type: none"> • turning the device on/off • setting to <i>blower</i> and pressing the button for 2s allows to change <i>Blower power in manual mode</i>.
	<ul style="list-style-type: none"> • return to the main menu

Table 10: Functions of the buttons on the manual control screen

3.2.9 Operating mode screen

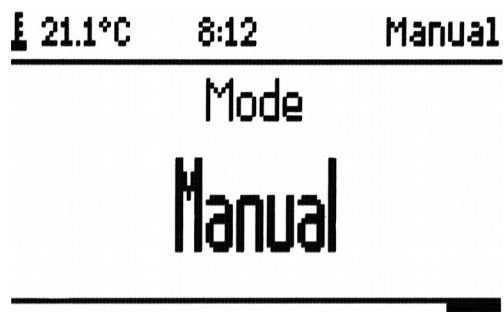

Picture 15: Operating mode screen

Manual	<ul style="list-style-type: none">• manual mode is used to manually turn on and off all the devices powered by the controller.
AUTO	<ul style="list-style-type: none">• operation with auto control of the combustion process
Alarm	<ul style="list-style-type: none">• operation of the devices with possible limitations, depending on the alarm type• return to the auto mode is possible only after removing the technical problem and confirming the alarm

Table 11: Operating modes

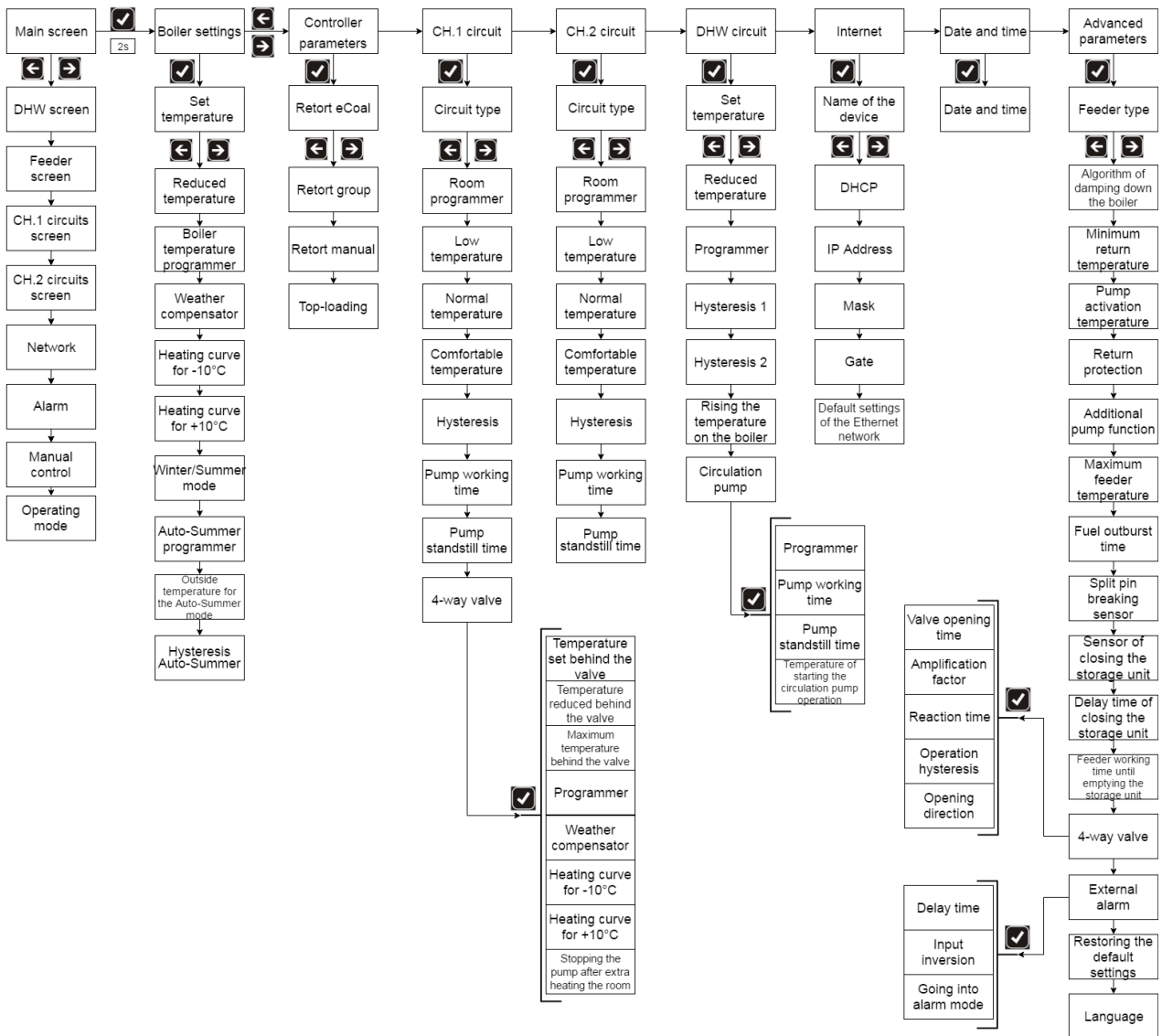

Picture 16: Controller menu plan

4. Controller parameters

4.1 Combustion parameters

No	Parameter	Description
1	Retort-eCoal	retort feeder, fully automatic combustion process.
2	Retort-group	retort feeder, semi-automatic combustion process.
3	Retort-manual	retort feeder, combustion process fully set by the operator.
4	Top-loading	option of an on-grate combustion with a stopped feeder.

4.1.1 Combustion parameters – Retort - eCoal type

Combustion process is fully automatic. The controller selects an optimal amount of air needed for fuel combustion, based on the analysis of exhaust temperature tendencies. Combustion parameters are chosen automatically without any service or operation. After choosing the boiler type, the user may only correct the feeder working time and the blower power.

No.	Parameter	Description
1	Blower correction	The correction is used to neutralize too strong chimney draught. <i>Range [-8% to +8%]</i>
2	Feeder working time	Fuel feeding time in the Heating mode. Standstill is calculated automatically, based on the algorithm. <i>Range [3s to 15s]</i>
3	Boiler type	Setting the output parameters of the combustion algorithm for a particular boiler type.

4.1.2 Combustion parameters – Retort - group type

Semi-automatic combustion process. The user has 6 powers to choose from with which the boiler can work. The user sets the minimum and maximum power and defines the blower power for them. Histogram may be helpful in determining the blower power. Switching the powers (Min and Max) is automatic. Minimum power is activated when the value drops below the boiler hysteresis ; maximum power is turned on when the temperature of the boiler drops below double hysteresis. When the set temperature is exceeded by +1°C the Uphold mode is engaged.

No.	Parameter	Description
1	Minimum power rating	Minimum power rating of the boiler from the range below
2	Maximum power rating	Maximum power rating of the boiler from the range below
3	Blower power for 8kW	Blower power for 8kW <i>Range [25% to 100%]</i>
4	Number of repetitions for 8kW	Defined number of feedings in the group for 8kW <i>Range [3 to 6]</i>

5	Blower power for 12kW	Blower power for 12kW <i>Range [25% to 100%]</i>
6	Number of repetitions for 12kW	Defined number of feedings in the group for 12kW <i>Range [3 to 6]</i>
7	Blower power for 16kW	Blower power for 16kW <i>Range [25% to 100%]</i>
8	Number of repetitions for 16kW	Defined number of feedings in the group for 16kW <i>Range [3 to 6]</i>
9	Blower power for 20kW	Blower power for 20kW <i>Range [25% to 100%]</i>
10	Number of repetitions for 20kW	Defined number of feedings in the group for 20kW <i>Range [3 to 6]</i>
11	Blower power for 25kW	Blower power for 25kW <i>Range [25% to 100%]</i>
12	Number of repetitions for 25kW	Defined number of feedings in the group for 25kW <i>Range [4 to 9]</i>
13	Blower power for 30kW	Blower power for 30kW <i>Range [25% to 100%]</i>
14	Number of repetitions for 30kW	Defined number of feedings in the group for 30kW <i>Range [4 to 9]</i>
15	Boiler hysteresis	Boiler temperature hysteresis. Temperature above the set value for the boiler – the Uphold mode is engaged; temperature below the set value minus hysteresis of the boiler – going into the Heating mode. <i>Range [0°C to 5°C]</i>

4.1.3 Combustion parameters – Retort - manual type

The combustion process is fully automatic. The user sets all the combustion parameters.

No.	Parameter	Description
1	Exhaust regulator	This function makes it possible to reduce chimney loss by decreasing the fan power when a set temperature of exhaust is exceeded. <i>Range [YES/NO]</i>
2	Maximum exhaust	Maximum exhaust temperature which will be sustained by the

	temperature	exhaust thermostat. Exceeding this temperature will result in reduction of the fan performance. <i>Range [90°C to 500°C]</i>
3	Minimum blower power	Minimum power for which the fan value will be reduced with active exhaust thermostat. <i>Range [25% to 100%]</i>
4	Feeder working time	Fuel feeding time in the Heating mode. <i>Range [3s to 30s]</i>
5	Feeder standstill time	The standstill time in the Heating mode – the standstill between each dose. <i>Range [10s to 600s]</i>
6	Blower power	The power of blower in the Heating mode. <i>Range [25% to 100%]</i>
7	Boiler hysteresis	Boiler temperature hysteresis. Temperature above the set value for the boiler – the Uphold mode is engaged; temperature below the set value minus <i>Hysteresis of the boiler</i> – going into the Heating mode. <i>Range [0°C to 5°C]</i>

4.1.4 Combustion parameters – top-loading type

The mode of on-grate combustion with a stopped feeder. The algorithm automatically reduces the blower power when the exhaust temperature exceeds 350°C and stops the blower when this temperature is higher than 400°C. In case of burning wood in the boiler remove the exhaust sensor from the flue.

No.	Parameter	Description
1	Purging time	Up to 8°C above the set temperature the controller makes automatic purging to remove gases from the chamber (it is very important for top-loaded boilers). The purging time defines the time during which the blower will be turned on. <i>Range [0s to 90s]</i>
2	Time between each purging	The time between one purging and the next. <i>Range [1min to 15min]</i>
3	Blower power	The power of the blower whit which it will be turned on in the heating mode. <i>Range [25% to 100%]</i>
4	Auto regulation	The parameter relates to the temperature range just before

No.	Parameter	Description
		reaching the set value, in which the controller automatically reduces the blower power. Within this range, together with the rise of the central heating temperature, the blower smoothly slows down until it reaches the level of the set temperature. When the temperature drops, the blower speed increases. <i>Range [0°C to 10°C]</i>
5	Boiler hysteresis	Boiler temperature hysteresis. Temperature above the set value for the boiler – the Uphold mode is engaged; temperature below the set value minus Hysteresis of the boiler – going into the Heating mode. <i>Range [0°C to 5°C]</i>

4.1.5 Uphold parameters

Uphold parameters are set for the combustion parameters: Retort eCoal, retort group, retort manual. These parameters can be find in the combustion settings of a particular combustion process (not for top-loaders.)

No.	Parameter	Description
1	Uphold: Feeder working time	Fuel feeding time in the Uphold mode. <i>Range [3s to 30s]</i>
2	Uphold: Feeder standstill time	The standstill time in the Uphold mode. <i>Range [3min to 360min]</i>
3	Uphold: Short break time	The short break time (standstill) of the feeder in the Uphold mode. In this mode the fuel feeding cycle has the following stages: [WORK-SHORT BREAK] - [WORK-SHORT BREAK] Cyclical work helps to burn down the fuel during the Uphold stage. The number of cycles can be defined in the next parameter. <i>Range [5s to 90s]</i>
4	Uphold: Number of feeding repetitions	Number of cycle repetitions: [WORK-SHORT BREAK] in the uphold. <i>Range [1 to 5]</i>
5	Uphold: Blower power	The power of blower in the Uphold mode. <i>Range [25% to 100%]</i>



4.1.6 Blower power in manual mode

The parameter allows to change the blower power in the manual mode. In this mode it is also possible to turn on/off each of the devices connected to the controller - see point **3.2.8 Manual control screen**.

No.	Parameter	Description
6	The power of blower in the manual mode.	The power of blower set in the manual mode. <i>Range [25% to 100%]</i>

4.2 Boiler settings

No.	Parameter	Description
1	Set temperature	The set temperature of water at the boiler outlet. <i>Range [42°C to 80°C]</i>
2	Reduced temperature	The value by which the set temperature of the boiler will be reduced when there is a reduced temperature set in a boiler programmer. <i>Range [0°C to 25°C]</i>
3	Boiler temperature programmer	The programmer is used to set the water temperature at the boiler outlet for each weekday. Programming the reduced temperature has also an impact on the work of the weather compensator.
4	Weather compensator	Activating the weather compensator. The compensator deducts an adequate temperature set for the boiler, based on outdoor temperature and a heating curve. Connecting wired or remote temperature sensors BT2 is a prerequisite for this function. The temperature set for the weather compensator is updated every 5 minutes. <i>Range [YES/NO]</i>
5	Heating curve for -10°C	The temperature set for the boiler with the outdoor temperature -10°C. <i>Range [42°C to 80°C]</i>
6	Heating curve for +10°C	The temperature set for the boiler with the outdoor temperature +10°C. <i>Range [42°C to 80°C]</i>
7	Winter/Summer mode	Defining the operating mode for the DHW circuit. Options: <ul style="list-style-type: none"> • Winter – both CH and DHW circuits working • Summer – only DHW circuit working

		<ul style="list-style-type: none"> Auto-Summer – Winter or Summer mode, depending on the outdoor temperature. Connecting wired or remote temperature sensors BT2 is a prerequisite for this function.
8	Auto-Summer programmer	Time settings of the mode for a particular weekday: <ul style="list-style-type: none"> Winter  Summer  Auto-Summer 
9	Outside temperature for the Auto-Summer mode	Outside temperature with which the controller is automatically switched to the Summer mode. <i>Range [5°C to 25°C]</i>
10	Automatic Summer Mode hysteresis	The parameter specifies the decrease of external temperature in the Automatic Summer Mode that activates the Winter Mode. <i>Range [0.3°C to 5°C]</i>

4.3 CH.1 circuit

Parameters for the first central heating circuit are defined in the settings. The first circuit is always active - no *Turn off* option. The pump for this circuit should be connected to the P1 output. The internal sensor for this circuit should be connected to the internal sensor output (T. WEW) - see *Picture 17*.

Instead of wired sensors, remote humidity and temperature sensors (BT1) can be applied. To enable this functionality, the controller should be upgraded with a RM1 radio module. The module allows to use also thermostatic heads (TH2) for radiators and wireless bars (HB1) for controlling thermoelectric valves of floor heating manifolds. It provides heat management at home via our website and our mobile application. You can find more information on <http://sklep.esterownik.pl/>.

When using a 4-way valve, the valve sensor should be connected to the T1 sensor input - see *Picture 17*.

An external thermostat can be connected to the controller. The thermostat should be connected to the **T.WEW** (internal temperature) contacts of the controller board (in the place of an internal sensor). The thermostat is required to have an potential-free contact. If the thermostat is connected, it produces a

controller reaction by switching the contacts. When the contacts are in a close state the boiler is set to heat. With an open state of the contacts the controller changes its mode to cooling, moreover the P1 pump can be in one of these modes: cyclic operation, continuous operation or turned off.

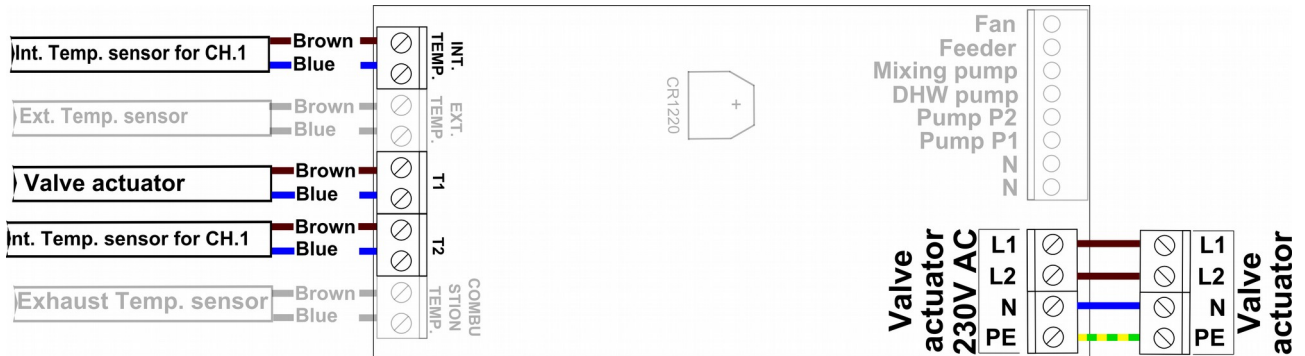

Picture 17: Connecting valve actuator and internal sensors for the CH.1 circuit

No.	Parameter	Description
1	Circuit type	<p>The definition of CH.1 circuit operation explains the following work parameters:</p> <ul style="list-style-type: none"> • CH pump – continuous work of P1 pump • CH pump + room regulator – P1 pump working based on the inside temperature coming from the programmer/external thermostat . Connecting wired or remote sensors BT1 is a prerequisite for this function. Ability to use external thermostat. • Floor pump – P1 pump working as a floor pump The P1 pump working based on the inside temperature coming from the programmer/external thermostat. Connecting wired or remote temperature sensors BT1 is a prerequisite for this function. Ability to use external thermostat. • CH pump + 4D – P1 pump and 4-way valve • CH pump + 4D + room regulator – P1 pump working with 4-way valve based on the inside temperature coming from the programmer/external thermostat. Connecting wired or remote temperature sensors BT1 is a prerequisite for this function. Ability to use external thermostat. • Floor pump – 4-way valve and P1 pump as a floor pump • Floor pump + 4D + room regulator – P1 pump working as a floor pump with 4-way valve based on inside temperature coming from the programmer/external thermostat.

		Connecting wired or remote temperature sensors BT1 is a prerequisite for this function. Ability to use external thermostat.
2	Room controller type	This parameter is defined as a source of information for the room controller: <ul style="list-style-type: none"> • Temperature sensor – the information about temperature is passed from an internal wired or wireless BT1 sensor. A weekly table of set point temperature for the room should be defined. • External thermostat – the information about heating mode is received from an external thermostat. That appliance replaces the weekly set point temperature table. <p style="text-align: center;"><i>Range [Internal sensor/Thermostat]</i></p>
3	Programmer	The parameter is used to set temperature for each weekday. Connecting wired or remote temperature sensors BT1 is a prerequisite for this function. Achieving the desired room temperature rearranges the controller in cooling mode – the ability to stop the pump P1 / P2. Ability to use external thermostat.
4	Low temperature	The parameter determines the value of a reduced temperature (e.g. night) in a room. Does not apply to external thermostat <i>Range [5°C to 35°C]</i>
5	Normal temperature	The parameter determines the value of a normal temperature (e.g. day) in a room. Does not apply to external thermostat <i>Range [5°C to 35°C]</i>
6	Comfortable temperature	The parameter determines the value of a comfortable (increased) temperature in a room. Does not apply to external thermostat <i>Range [5°C to 35°C]</i>
7	Hysteresis	The parameter determines the value by which the internal temperature should be decreased for the controller to decide that a room extra heating procedure should be started. <i>Range [0°C to 5°C]</i>
8	Pump working time	The parameter determines the working time of the P1 pump for an active Programmer/external thermostat . Setting <i>0mm</i> means that the P1 pump will be turned off after reaching the set temperature in the room. <i>Range [0min to 240min]</i>
9	Pump standstill time	The parameter determines the standstill time of the P1 pump for an active Programmer/external thermostat . <i>Range [1min to 250min]</i>
10	4-way valve	Group of parameters concerning the operation of the 4-way valve (only for the CH.1 circuit)
10.1	Temperature set	Water temperature set behind the valve.

	behind the valve	<i>Range [20°C to 80°C]</i>
10.2	Temperature reduced behind the valve	The value by which the set temperature behind the valve will be reduced when there is set a reduced temperature in a programmer. <i>Range [0°C to 25°C]</i>
10.3	Maximum temperature behind the valve	Reaching this temperature results in generating the alarm: <i>High temperature behind the 4-way valve</i> . The valve is additionally closed for floor heating. <i>Range [20°C to 80°C]</i>
10.4	Programmer	The programmer is used to set the water temperature behind the valve for each weekday. Programming the reduced temperature has also an impact on the work of the weather compensator.
10.5	Weather compensator	Activating the weather compensator. The compensator deducts an adequate temperature set behind the valve, based on outdoor temperature and a heating curve. Connecting an external sensor is a prerequisite for this function. The temperature set for the weather compensator is updated every 5 minutes. <i>Range [YES/NO]</i>
10.6	Heating curve for -10°C	The temperature set behind the valve with the outdoor temperature -10°C. <i>Range [20°C to 80°C]</i>
10.7	Heating curve for +10°C	The temperature set behind the valve with the outdoor temperature +10°C. <i>Range [20°C to 80°C]</i>
10.8	Stopping the pump after extra heating the room	The parameter determines if after reaching the temperature in the room, the pump should stop or only reduce the temperature behind the valve. <i>Range [YES/NO]</i>

4.4 CH.2 circuit screen

Parameters for the second central heating circuit are defined in these settings. The parameters are the same as for the first CH.1 circuit. It is also possible to turn off this circuit. The receiver for this circuit should be connected to the P2 output. The internal sensor for this circuit should be connected to the T2 sensor input - see *Picture 17*.

It is not possible to define the valve actuator for this circuit.



Instead of wired sensors, remote humidity and temperature sensors (BT1)

can be applied. To enable this functionality, the controller should be upgraded with a RM1 radio module. The module allows to use also thermostatic heads (TH2) for radiators and wireless bars (HB1) for controlling thermoelectric valves of floor heating manifolds. It provides heat management at home via our website and our mobile application. You can find more information on <http://sklep.esterownik.pl/>.

An external thermostat can be connected to the controller. The thermostat should be connected to the **T2** contacts of the controller board (in the place of an internal sensor). The thermostat is required to have an potential-free contact. If the thermostat is connected, it produces a controller reaction by switching the contacts. When the contacts are in a close state the boiler is set to heat. With an open state of the contacts the controller changes its mode to cooling, moreover the P1 pump can be in one of these modes: cyclic operation, continuous operation or turned off.

4.5 DHW circuit

No	Parameter	Description
1	Set temperature	The temperature set for the DHW storage unit. <i>Range [20°C to 60°C]</i>
2	Reduced temperature	The value by which the set temperature of the domestic hot water will be reduced when there is too low temperature set on the weekly chart. <i>Range [0°C to 25°C]</i>
3	Programmer	The programmer is used to set the temperature of DHW for each weekday.
4	Hysteresis #1	The hysteresis of starting the DHW loading pump. <i>Range [0°C to 10°C]</i>
5	Hysteresis #2	The hysteresis for achieving <i>the DHW priority</i> – activating the DHW loading pump and stopping the P1 and P2 pump. Choosing 30°C deactivates the priority option. <i>Range [0°C to 30°C]</i>
6	Rising the temperature on the boiler	Setting the rising (increase) of the set temperature on the boiler in order to warm up water in the storage unit with an active DHW priority.

		<i>Range [0°C to 20°C]</i>
7	Circulation pump	The group of parameters related to the operation of the DHW circulation pump.
7.1	Programmer	<p>The programmer is used to set the temperature of the DHW circulation pump for each weekday. Options:</p> <ul style="list-style-type: none"> •  - pump turned off •  - pump turned on •  - cyclical work of the pump in accordance with the 7.2 and 7.3 parameters.
7.2	Pump working time	<p>Pump working time for the cyclic mode.</p> <p style="text-align: right;"><i>Range [1min to 240min]</i></p>
7.3	Pump standstill time	<p>Pump standstill time for the cyclic mode.</p> <p style="text-align: right;"><i>Range [1min to 240min]</i></p>
7.4	Temperature of starting the circulation pump operation	<p>The prerequisite for starting the circulating pump – minimum temperature in the DHW storage unit. Hysteresis for turning off 0.5°C</p> <p style="text-align: right;"><i>Range [25°C to 60°C]</i></p>

4.6 Programmers

The programmers are used to support and automate settings in a defined day range, depending on the user's needs. There are 6 programmers available:

- Boiler temperature programmer
- DHW programmer
- Room thermostat for the CO.1 circuit
- Room thermostat for the CO.2 circuit
- Circulation pump programmer
- Auto-Summer programmer

Select a weekday for the programmer



Picture 18: Weekday selection screen

	<ul style="list-style-type: none"> • weekday selection
	<ul style="list-style-type: none"> • confirm the selection and go to the programmer
	<ul style="list-style-type: none"> • return

Table 12: The functions of the buttons for the weekday selection screen for the programmer

Programmer operation

















Picture 19: Boiler programmer screen

	<ul style="list-style-type: none"> • time selection / programmer overview
	<ul style="list-style-type: none"> • action/task selection
	<ul style="list-style-type: none"> • save changes
	<ul style="list-style-type: none"> • cancel changes / return to the overview mode - magnifying glass

Table 13: The functions of the buttons for the programmer screens

Actions/tasks available in different programmers

Programmers	Operation	Description
Programmer boiler temperatures		Set temperature
		Reduced temperature
DHW programmer		The DHW function is turned off
		The DHW function is active - the set temperature
		The DHW function is active - the reduced temperature
Room programmer for the CH.1 and CH.2 circuit		Frost protection 7°C
		Low temperature
		Normal temperature
		Comfortable temperature
Circulation pump programmer		Pump turned off
		Pump activated
		Cyclical work of the pump
Auto-Summer programmer		Winter mode
		Summer mode
		Auto-Summer mode

4.7 Internet

Options allowing to set parameters which make it possible to connect the controller by means of the Ethernet.

CAUTION! After changing settings in the Internet parameters it is

necessary to restart the controller to validate the changes.



CAUTION! After connecting the controller to the Internet it will automatically update its software.

No	Parameter	Description
1	Name of the device	The name of the controller which is seen on the eSterownik.pl platform - reading only
2	DHCP	<ul style="list-style-type: none">• YES - automatic reading the IP address parameters from a DHCP server• NO - setting the IP address manually
3	IP Address	The IP address of the controller which is seen in the local network
4	Mask	Network mask
4	Gate	Default gate
5	Default settings of the Ethernet network	Restoring the default settings of the Ethernet and resetting the login passwords of the local website. The default user for the local website: root, the password: root

Find the instructions for connecting the controller to the eSterownik.pl platform on the www.esterownik.pl.

4.8 Date and time

This option is used to set time and date for proper operation of programmers. After selecting the Time and date option a window with the time set for the controller will be displayed. In case of a controller connected to the Internet the time and date will be automatically synchronized with the SNTP server.

	<ul style="list-style-type: none">• change of date and time position
	<ul style="list-style-type: none">• change the value



	<ul style="list-style-type: none"> choice confirmation
	<ul style="list-style-type: none"> return

Table 14: The functions of the buttons for the time and date screens

4.9 Advanced parameters

No.	Parameter	Description
1	Feeder type	<p>Selection of the feeder operation (combustion algorithm):</p> <ul style="list-style-type: none"> Retort eCoal – retort feeder, fully automatic combustion process Retort Group – retort feeder, semi-automatic combustion process Retort Manual – retort feeder, combustion process fully set by the operator Top-loaded – option of an on-grate combustion
2	Algorithm of damping down the boiler	<p>Detection of boiler damping down in the Uphold and Heating mode, based on the exhaust temperature:</p> <ul style="list-style-type: none"> Inactive – turning off the boiler damping down detection Heating only – boiler damping down detection only in the Heating mode Uphold only – boiler damping down detection only in the Uphold mode Always – boiler damping down detection both in the Heating and Uphold mode.
3	Minimum return temperature	<p>The minimum value of the return temperature below which the mixing pump will be activated</p> <p><i>Range [35°C to 60°C]</i></p>
4	Pump activation temperature	<p>The value of the outlet water temperature below which the following pumps can be activated: P1, P2, mixing, DHW, boiler feed pump</p> <p><i>Range [35°C to 60°C]</i></p>
5	Return protection	<ul style="list-style-type: none"> DHW pump – the DHW pump acts as a storage unit loading pump and a mixing pump Mixing pump – using the mixing pump. <p>Pump turning off hysteresis amounts 2°C</p> <ul style="list-style-type: none"> 4-wayvalve – return protection by means of a 4-way valve It is necessary in this case to use a gravity flow of water in the small 4-way valve cycle from the boiler side. Otherwise an additional circulation pump should be installed. In case of using a 3-way valve it is not possible to have a

No.	Parameter	Description
		<p>return protection and a smooth temperature control behind the valve at the same time. When a CH pump is installed with a 3-way valve, temperature control behind the valve is possible, but a return protection is not. When a CH pump is installed with a 3-way valve, a return protection is possible, but temperature control behind the valve is not.</p> <p>Therefore, a 4-way valve is necessary to have both a return protection and a smooth temperature control behind the valve at the same time.</p>
6	Additional pump function	<ul style="list-style-type: none"> • mixing pump – sustaining the minimum temperature of the water returning to the boiler • circulation pump – it is intended to ensure a constant water circulation from the storage unit to the point of drawing water • boiler pump – small cycle pump between the boiler and a buffer.
7	Maximum feeder temperature	<p>The limiting temperature of the feeder exceeding which will activate an alarm</p> <p style="text-align: center;"><i>Range [40°C to 110°C]</i></p>
8	Fuel outburst time	<p>The time of activating the feeder after the following alarm appeared: Fuel ignition in the feeder.</p> <p style="text-align: center;"><i>Range [1min to 10min]</i></p>
9	Split pin breaking sensor	<p>Activating the function of feeder damage detection</p> <p style="text-align: center;"><i>Range [YES/NO]</i></p>
10	Sensor of closing the storage unit	<p>Activating the function of open storage unit detection</p> <p style="text-align: center;"><i>Range [YES/NO]</i></p>
11	Delay time of closing the storage unit	<p>The time after which an Open feeder alarm will be reported</p> <p style="text-align: center;"><i>Range [0s to 60s]</i></p>
12	Feeder working time until emptying the storage unit	<p>The time of feeder operation after which the storage unit will be emptied and the following alarm reported: Empty storage unit. Setting 0min for the parameter disables the function.</p> <p style="text-align: center;"><i>Range [0min to 999min]</i></p>
13	4-way valve	Group of parameters concerning the operation of the 4-way valve
13.1	Valve opening time	<p>The time when the valve is fully open. This time is given on the valve name plate.</p> <p style="text-align: center;"><i>Range 30s to 600s</i></p>
13.2	Amplification factor	<p>The amplification factor of the difference between the set and the currently measured temperatures. The higher the factor, the</p>

No.	Parameter	Description
		bigger the individual steps of the valve. <i>Range [0 to 2.0]</i>
13.3	Reaction time	Defines the time after which the valve corrects its position <i>Range [10s to 600s]</i>
13.4	Operation hysteresis	If the difference between the set and the measured temperature is lower than the value of <i>Operation hysteresis</i> , the valve does not correct its position <i>Range [0°C to 10°C]</i>
13.5	Opening direction	Indication of the valve opening direction <i>Range [right/left]</i>
14	External alarm	A group of parameters for an external alarm. Connecting a potential-free contact to the output of <i>External alarm</i> allows to signal external incidents which occurred in the boiler room.
14.1	Delay time	The time of delay after which an alarm will be reported <i>Range [0s to 600s]</i>
14.2	Input inversion	Setting a reversed logic for an alarm input <i>Range [YES/NO]</i>
14.3	Going into alarm mode	An option to automatically stop the combustion process after the alarm <i>Range [YES/NO]</i>
15	Restoring the default settings	A possibility to restore the default settings of the controller parameters. <i>Range [YES/NO]</i>
16	Language	Choose the language of the control panel

5. Alarms

An alarm is signaled by a red LED light on the control panel  and an audible signal (which is stopped by pressing any button on the panel – it does not mean cancelling the alarm). Turning off and restarting the controller supply confirms alarms as well - only if the cause was removed.

No.	The name of the alarm	Description	Automatic alarm stopping
1	Thermal protection	Activation of the thermal protection of the boiler -	No

No.	The name of the alarm	Description	Automatic alarm stopping
		protection against water boiling. After the alarm is reported it is necessary to wait until the water temperature in the boiler drops below 50°C, before the alarm can be canceled.	
2	Boiler temp. more than 90°C	Water temperature in the boiler exceeded 90°C	No
3	Sensor damaged Temperature of the boiler	Sensor of the boiler damaged	No
4	Sensor damaged DHW temp.	DHW sensor damaged	Yes
5	Sensor damaged return temp.	Return sensor damaged	Yes
6	Internal sensor damaged	Internal sensor damaged	Yes
7	External sensor damaged	External sensor damaged	Yes
8	Sensor damaged feeder temp.	Feeder sensor damaged	No
9	Sensor damaged exhaust temp.	Exhaust sensor damaged	No
10	Sensor damaged T1	T1 sensor damaged When the sensor acts as a valve sensor, the failure of the circuit in: <ul style="list-style-type: none"> • floor heating - the valve will be closed • central heating - the valve will be open 	Yes
11	Sensor damaged T2	T2 sensor damaged	Yes
12	Fuel ignition in the feeder	Fuel ignition in the feeder – exceeding the maximum temperature of the feeder	No
13	High feeder temperature	Too high feeder temperature	Yes
14	Boiler put out	The boiler was put out - the alarm relates to the Uphold and Heating mode. When: <ul style="list-style-type: none"> - in the Heating mode - the exhaust temperature does not exceed 50°C in 30min. Check if the boiler exchanger and the flue are clean. - in the Uphold mode - after starting the uphold procedure the exhaust temperature does not increase by 5°C. Incorrectly set parameters of the Uphold mode. 	No
15	Dirty boiler	The boiler got dirty - check if the boiler exchanger and the flue are clean.	No

No.	The name of the alarm	Description	Automatic alarm stopping
16	High exhaust temperature	Too high exhaust temperature - check if the components of the boiler exchanger are properly mounted.	Yes
17	IP addresses conflict	Conflict of IP addresses - this IP address is already reserved	Yes
18	SD card error	No microSD card or missing	Yes
19	External alarm	Open/close CONT contact on the controller plate – universal alarm input. When the alarm occurs check if to the CONT input a sensor has not been connected or Advanced parameters – External alarm - Input inversion has not been changed to Yes	No
20	Empty storage unit	Low level of fuel in the storage unit - this alarm does not stop the boiler work. It is used for making statistics of fuel combustion. The alarm option is disabled by setting Feeder working time until emptying the storage unit to 0min. Alarm is cleared by adding a new batch of fuel.	No
21	STB	External thermal protection of the boiler	No
22	Feeder error	The feeder is not connected or there was a power supply failure in this circuit	No
23	Broken split pin	A problem with the feeder – a broken split pin, feeder jamming (e.g. a stone in the fuel). Check the split pin and see if the feeder rotates after turning it on. The alarm appears also when no sensor is connected or when it is incorrectly connected.	No
24	Open storage unit	Open (not closed) feeder cover Check if the feeder cover is well closed. The alarm appears also when no sensor is connected or when it is incorrectly connected.	Yes
25	High temperature behind the 4-way valve	Only for floor heating: <i>Maximum temperature behind the 4-way valve</i> has been exceeded. The valve can be closed for floor heating.	No

Declaration of conformity

ELEKTRO-SYSTEM s.c. with its official seat at ul. Sienkiewicza 25 in Kutno hereby declares that the product:

Adaptive controller eCoal.pl V3.5

complies with the provisions of the following European Directives:

- Directive 2006/95/EC of the European Parliament and of the Council on the harmonization of the laws of Member States relating to electrical equipment designed for use within certain voltage limits
- Directive 2004/108/EC of the European Parliament and of the Council on the approximation of the laws of the Member States relating to electromagnetic compatibility and repealing Directive 89/336/EEC

Compliance with these directives is ensured through respecting the following standards:

PN-EN 60730-2-9:2006 in conjunction with PN-EN 60730-1:2002 + A1:2008 + A2:2009 + A12:2004 + A13:2005 + A14:2006 + A15:2009 + A16:2009 + Ap1:2007

IEC 60730-2-9:2008 (Third Edition) in conjunction with IEC 60730-1:1999 (Third Edition) + A1:2003+ A2:2007

The last two digits of the number of the year in which the CE marking was affixed: **'15**

This declaration is not a guarantee of product properties within the meaning of the Product Liability Law. Safety requirements defined in the Operations Manual must be adhered to.

In accordance with Low Voltage Directive, the installation and connection of the products with the CE marking made in line with the Operations Manual must comply to the requirements stipulated in Electromagnetic Compatibility Directive (EMC).

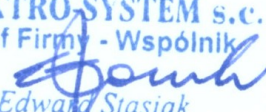
ELEKTRO-SYSTEM s.c.
Szef Firmy - Wspólnik

Edward Stasiak

Kutno, dated 10-08-2015

WARRANTY CARD

Name of the device	Adaptive controller eCoal.pl V3.5
Production date	
Recipient	
Invoice number	
Date of sale	

Terms and conditions:

1. ELEKTRO-SYSTEM s.c., hereinafter referred to as the Guarantor, ensures a good quality and efficient operation of the purchased equipment, when used in accordance with its intended purpose and this manual.
2. The warranty applies to equipment failures, resulting from faulty parts or production defects, arisen during 24 months from the date of sale.
3. Damaged equipment should be delivered to the point of purchase at the client's own cost.
4. Any faults found will be removed within 14 working days following the date of delivery.
5. This warranty card is the only document entitling the purchaser to a free of charge repair under warranty. A warranty card without a date, stamp and signatures is invalid. Duplicates will not be issued for a lost warranty card.
6. The warranty does not include damages arising as a result of operation that is inconsistent with the intended use, due to the user's fault, mechanical defects or those resulting from lightning and/or power-line surges. A fuse on the controller protects the components against overload but not short-circuit. Before the heating period motors of the pumps, the fan and the feeder should be checked by connecting them directly to ~230V network.
7. The warranty does not cover for damages and faults resulting from:
unauthorized repair, modification or design changes made by the client,
operating and handling the installation in an improper way or not as indicated in this manual (incorrect power supply, maximum load exceeded, too high humidity), mechanical damage caused during transport, assembly or operation, random events caused by electrostatic discharges, fire, flood, power surges, short circuits or current leakage etc.

stamp of the seller

Elektro-System s.c.

ul. Sienkiewicza 25

99-300 Kutno

Tel: +48 24 253 76 63

Tel: +48 24 355 05 63

Mob: +48 605 780 882

Fax: +48 24 355 05 73

www.eSterownik.pl

serwis@elektro-system.com